

LH0033 / LH0033C

FEATURES

- Slew rate..... 1500V/ μ s
- Wide range single or dual supply operation
- Bandwidth 100MHz
- High output drive..... $\pm 10V$ with 50Ω load
- Low phase non-linearity 2 degrees
- Rise times 3ns
- High input resistance:..... $10^{10}\Omega$
- High output current (peak)..... 250mA

APPLICATIONS

- Coaxial Cable Driver
- Fast Op Amp Booster
- Flash Converter Driver
- Video Line Driver
- High Speed Sample and Hold
- ATE Pin Driver
- Video Amplifier
- Radar
- Sonar
- Boost OP Amp Output
- Isolate Capacitance Load

GENERAL DESCRIPTION

The LH0033 is a high speed, FET input, voltage follower/buffer designed to provide high current drive (up to 100mA) at frequencies from DC to over 100MHz. The LH0033 slews at 1500V/ μ s and exhibits excellent phase linearity up to 20MHz.

LH0033 is intended to fulfill a wide range of buffer applications such as high speed line drivers, video impedance transformation, nuclear instrumentation amplifiers, op amp isolation buffers for driving reactive loads and high impedance input buffers for high speed A to Ds and comparators. In addition, the LH0033 can continuously drive 50Ω coaxial cables or be used as a yoke driver for high resolution CRT displays.

This device is constructed using specially selected junction FETs and active laser trimming to achieve guaranteed performance specifications. The LH0033 is specified for operation from $-55^{\circ}C$ to $+125^{\circ}C$ and the LH0033C is specified from $-25^{\circ}C$ to $85^{\circ}C$. The LH0033 is available in a 2.2W metal TO-8 package.

ORDERING INFORMATION

Part	Package	Temperature Range
LH0033G	H12A (TO8 12 Lead)	$-55^{\circ}C$ to $125^{\circ}C$
LH0033CG	H12A (TO8 12 Lead)	$-25^{\circ}C$ to $85^{\circ}C$

CONNECTION DIAGRAM

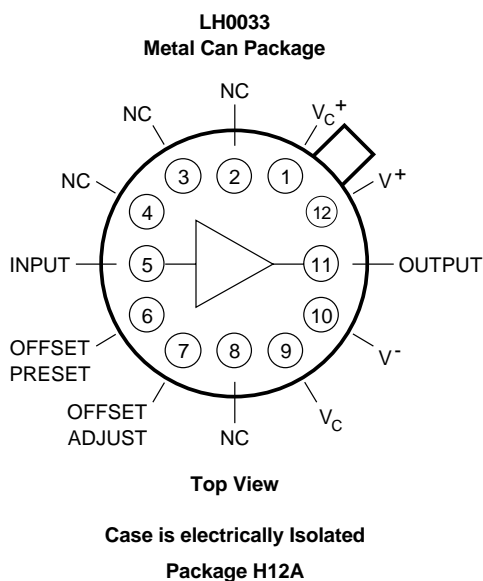

ABSOLUTE MAXIMUM RATINGS

If Military/Aerospace specified devices are required, please contact Calogic Sales Office for availability and specifications.

Supply Voltage ($V^+ - V^-$)	40V
Power Dissipation (See Curves)	
LH0033/LH0033C	2.2W
Junction Temperature	175°C
Input Voltage	$\pm V_{Supply}$

Continuous Output Current	
LH0033/LH0033C	$\pm 100\text{mA}$
Peak Output Current	
LH0033/LH0033C	$\pm 250\text{mA}$
Lead Temp. (Soldering, 10 seconds)	300°C
Operating Temperature Range	
LH0033	-55°C to +125°C
LH0033C	-25°C to +85°C
Storage Temperature Range	-65°C to +150°C

DC ELECTRICAL CHARACTERISTICS: The following specifications apply for supply voltage = $\pm 15\text{V}$ unless otherwise noted (Note 1)

SYMBOL	CHARACTERISTICS	LH0033			LH0033C			UNITS	CONDITIONS
		MIN	TYP	MAX	MIN	TYP	MAX		
V_{OS}	Output Offset Voltage		5.0	10 15		12	20 25	mV mV	$R_S = 100\Omega$, $T_J = 25^\circ\text{C}$, $V_{IN} = 0\text{V}$ (Note 2), $R_S = 100\Omega$
$\frac{\Delta V_{OS}}{\Delta T}$	Average Temperature Coefficient of Offset Voltage		50	100		50	100	$\mu\text{V}/^\circ\text{C}$	$R_S = 100\Omega$, $V_{IN} = 0\text{V}$ (Note 3)
I_B	Input Bias Current			250 2.5 10			500 5.0 20	pA nA nA	$V_{IN} = 0\text{V}$ $T_J = 25^\circ\text{C}$ (Note 2) $T_A = 25^\circ\text{C}$ (Note 4) $T_J = T_A = T_{MAX}$
A_V	Voltage Gain	0.97	0.98	1.00	0.96	0.98	1.00	V/V	$V_O = \pm 10\text{V}$, $R_S = 100\Omega$, $R_L = 1.0\text{k}\Omega$
R_{IN}	Input Impedance	10^{10}	10^{11}		10^{10}	10^{11}		Ω	$R_L = 1\text{k}\Omega$
R_{OUT}	Output Impedance		6.0	10		6.0	10	Ω	$V_{IN} = \pm 1.0\text{V}$, $R_L = 1.0\text{k}$
$V_{(SWING 1)}$	Output Voltage Swing	± 12			± 12			V	$V_I = \pm 14\text{V}$, $R_L = 1.0\text{k}$
$V_{(SWING 2)}$		± 9.0			± 9.0				$V_I = \pm 10.5\text{V}$, $R_L = 100\Omega$, $T_A = 25^\circ\text{C}$
I_S	Supply Current		18	22		18	24	mA	$V_{IN} = 0\text{V}$ (Note 5)
P_D	Power Consumption		540	660		540	720	mW	$V_{IN} = 0\text{V}$

AC ELECTRICAL CHARACTERISTICS: $T_J = 25^\circ\text{C}$, $V_S = \pm 15\text{V}$, $R_S = 50\Omega$, $R_L = 1.0\text{k}\Omega$ (Note 3)

SYMBOL	CHARACTERISTICS	LH0033			LH0033C			UNITS	CONDITIONS
		MIN	TYP	MAX	MIN	TYP	MAX		
S_R	Slew Rate	1000	1500		1000	1400		V/ μs	$V_{IN} = \pm 10\text{V}$
BW	Bandwidth		100			100		MHz	$V_{IN} = 1.0\text{V}_{rms}$
	Phase Non- Linearity		2.0			2.0		degrees	$BW = 1.0\text{Hz}$ to 20MHz
R_T	Rise Time		2.9			3.2		ns	$\Delta V_{IN} = 0.5\text{V}$
	Propagation Delay		1.2			1.5		ns	$\Delta V_{IN} = 0.5\text{V}$
	Harmonic Distortion		<0.1			<0.1		%	$f > 1\text{kHz}$

Note 1: LH0033 is 100% production tested as specified at 25°C. Specifications at temperature extremes are verified by sample testing, correlation or periodic characterization.

Note 2: Specification is at 25°C junction temperature due to requirements of high speed automatic testing. Actual values at operating temperature will exceed the value at $T_J = 25^\circ\text{C}$. When supply voltages are $\pm 15\text{V}$, no-load operating junction temperature may rise 40-60°C above ambient, and more under load conditions. Accordingly, V_{OS} may change one to several mV, and I_B will change significantly during warm-up.

Note 3: Limits are guaranteed by sample testing, periodic characterization or correlation.

Note 4: Measured in still air 7 minutes after application of power. Guaranteed through correlated automatic pulse testing.

Note 5: Guaranteed through correlated automatic pulse testing at $T_J = 25^\circ\text{C}$.

TYPICAL PERFORMANCE CHARACTERISTICS

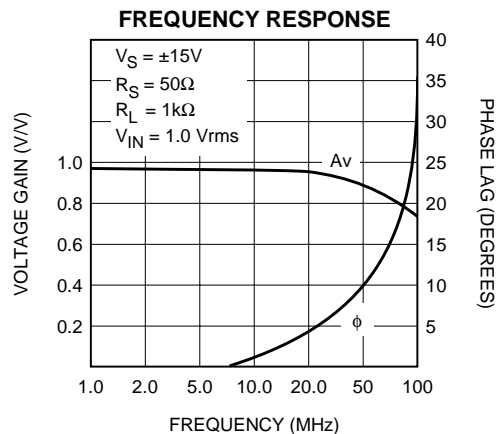
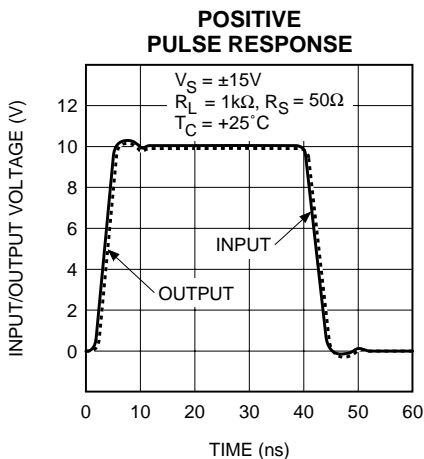
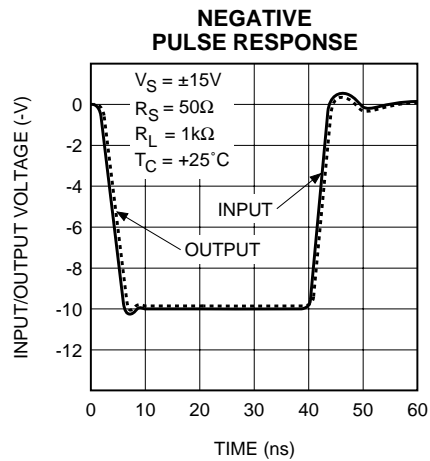
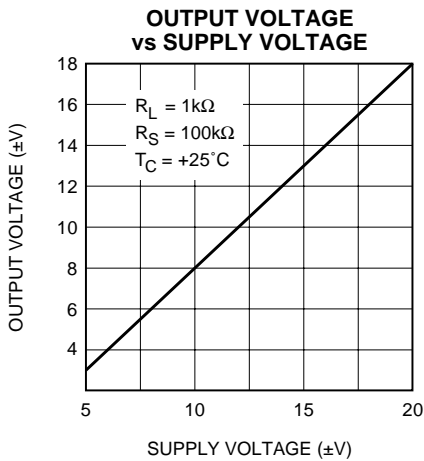
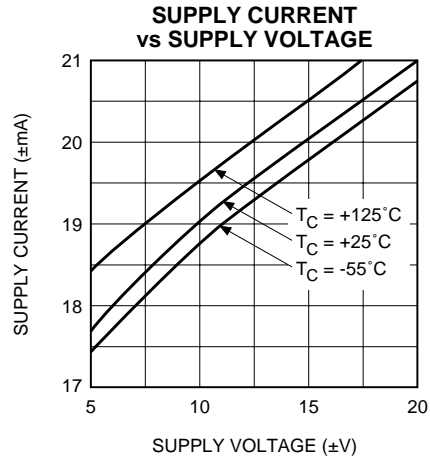
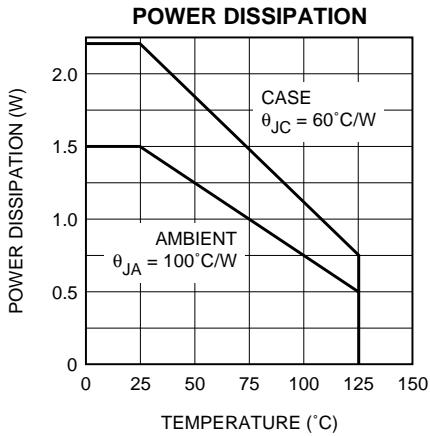

TYPICAL PERFORMANCE CHARACTERISTICS (Continued)

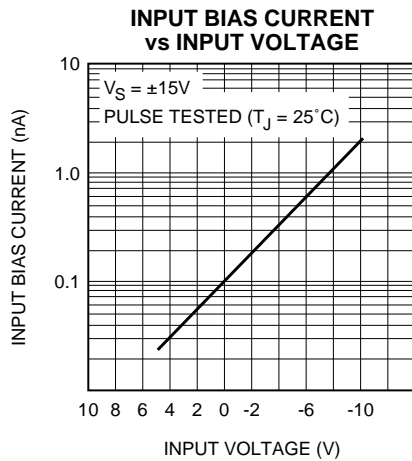
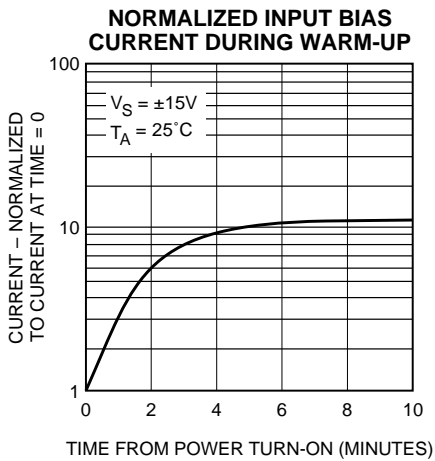
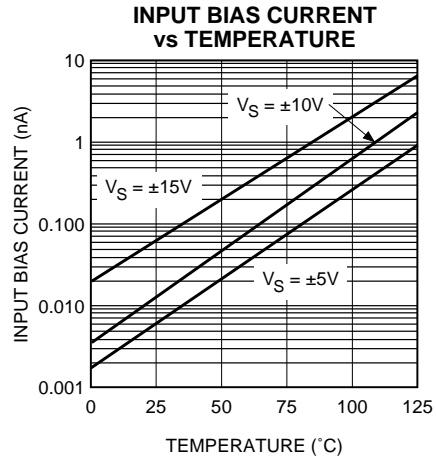
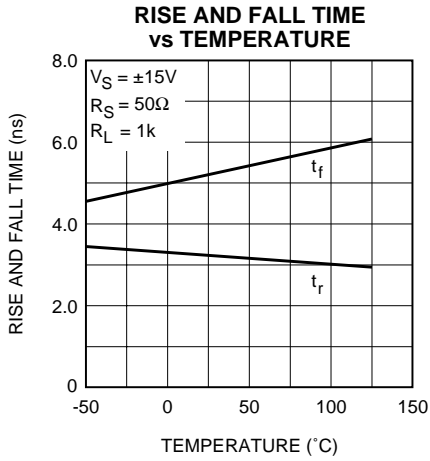

APPLICATION INFORMATION:

Recommended Layout Precautions

RF/video printed circuit board layout rules should be followed when using the LH0033 since it will provide power gain to frequencies over 100MHz. Ground planes are recommended and power supplies should be decoupled at each device with low inductance capacitors. In addition, ground plane shielding may be extended to the metal case of the device since it is electrically isolated from internal circuitry. Alternatively the case should be connected to the output to minimize input capacitance.

Offset Voltage Adjustment

The LH0033's offset voltages have been actively trimmed by laser to meet guaranteed specifications when the offset preset pin is shorted to the offset adjust pin. If offset null is desirable, it is simply obtained by leaving the offset preset pin open and connecting a trim pot of 200Ω for the LH0033 between the offset adjust pin and V⁻, as illustrated in Figure 1.

Operation From Single Or Asymmetrical Power Supplies

LH0033 may be used in applications where symmetrical supplies are unavailable or not desirable. A typical application might be an interface to a MOS shift register where V⁺ = +5V and V⁻ = -12V. In this case, an apparent output offset occurs due to the device's voltage gain of less than unity. This additional output error may be predicted by:

$$\Delta V_O \cong (1-A_V) \frac{(V^+ - V^-)}{2} = 0.005 (V^+ - V^-)$$

where:

A_V = No load voltage gain, typically 0.99

V⁺ = Positive supply voltage

V⁻ = Negative supply voltage

For the above example, ΔV_O would be -35mV. This may be adjusted to zero as described in Figure 1. For AC coupled applications, no additional offset occurs if the DC input is properly biased as illustrated in the Typical Applications section.

Short Circuit Protection

In order to optimize transient response and output swing, output current limit has been omitted from the LH0033. Short circuit protection may be added by inserting appropriate value resistors between V⁺ and V_C⁺ pins and V⁻ and V_C⁻ pins as illustrated in Figure 2. Resistor values may be predicted by:

$$R_{LIM} \cong \frac{V^+}{I_{SC}} = \frac{V^-}{I_{SC}}$$

where:

I_{SC} ≤ 100mA for LH0033

The inclusion of limiting resistors in the collectors of the output transistors reduces output voltage swing. Decoupling V_C⁺ and V_C⁻ pins with capacitors to ground will retain full output swing for transient pulses. Alternate active current limit techniques that retain full DC output swing are shown in

FIGURE 1. Offset Zero Adjust

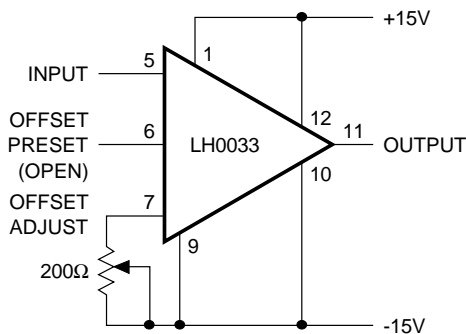
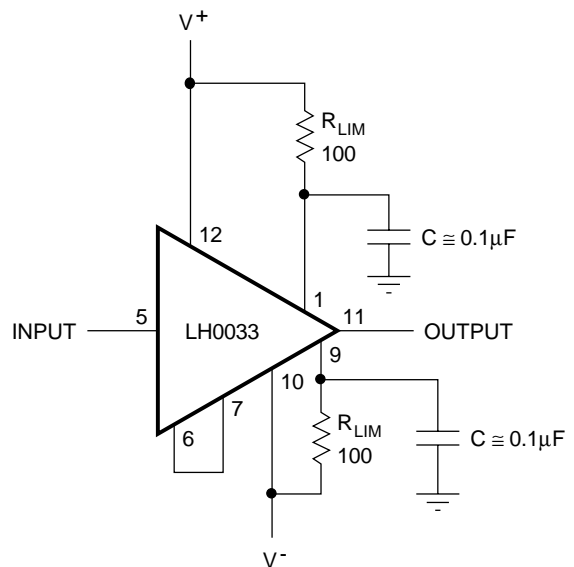
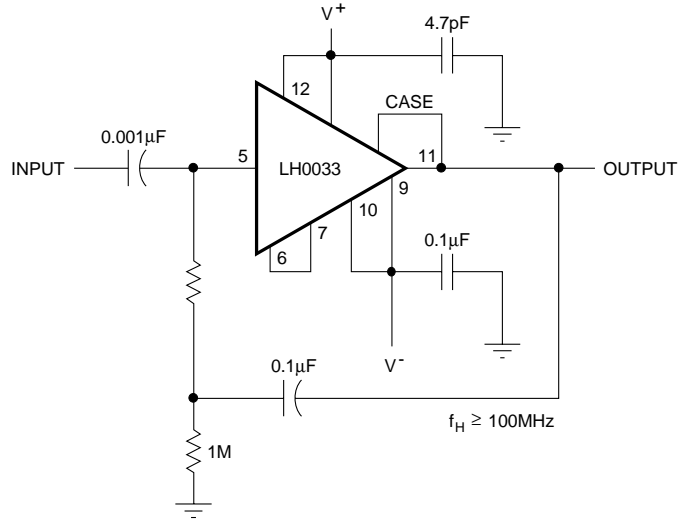

FIGURE 2. Resistor Current Limiting Using Resistor



TYPICAL APPLICATIONS

High Input Impedance AC Coupled Amplifier



Coaxial Cable Driver

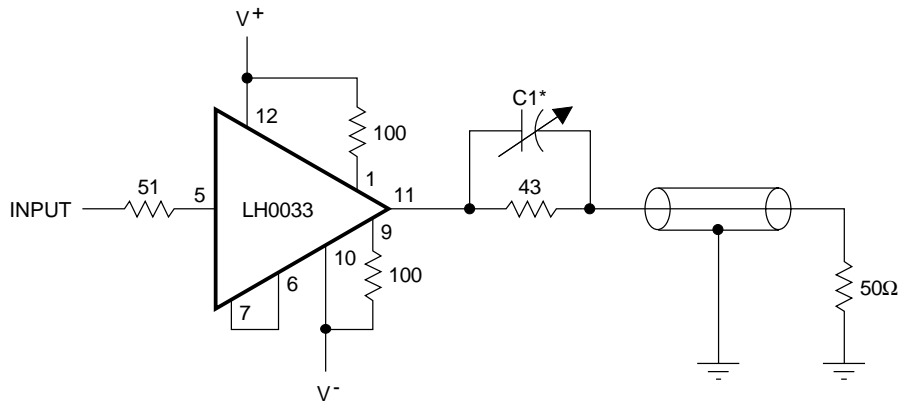

*Select C1 for Optimum Pulse Response

TYPICAL APPLICATIONS (Continued)

